

Top Glass holds a warehouse with a wide assortment of TRIGLASS® fiberglass profiles for prompt delivery. Below is a list of different in-stock profiles classified by **product group**, **length**, **colour** and the **number of pieces** per standard package.

In order to know our up-to-date and available stock of pultruded profiles, contact our **sales office** by sending a **request** directly through our website.

## ROUND PROFILES

DESCRIPTION D [mm]	COLOUR	LENGHT [mm]	STANDARD PACK [pcs.]
2,5	Natural	2.640	200
3	Natural	2.000	100
4	Natural	2.000	100
5	Natural	2.000	100
6	Natural	2.000 / 4.000	100 / 50
7	Natural	2.000	100
8	Natural	2.000	50
9	Natural	2.000	50
10	Natural	2.000	50
12	Natural	2.000	25
14	Natural	2.000	25
16	Natural	2.000	25
18	Natural	2.000	20
20	Natural	2.000	20

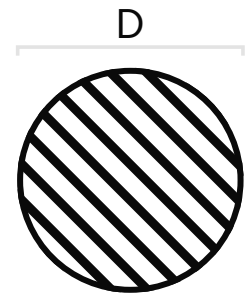

## DOG BONES

DESCRIPTION B X H X T [mm]	COLOUR	LENGHT [mm]	STANDARD PACK [pcs.]
8 x 6 x 3	Natural	2.000 / 2.500	50 / 50
10 x 8 x 4	Natural	2.000 / 2.500	50 / 50
12 x 10 x 5	Natural	2.000 / 2.500	50 / 50 / 25
14 x 10 x 5	Natural	2.000 / 2.500	50 / 25
16 x 12 x 6	Natural	2.000 / 3.000	25 / 25
16 x 13 x 6,5	Natural	2.500	25
18 x 14 x 7	Natural	2.000 / 3.000	25 / 20
20 x 16 x 8	Natural	2.000 / 3.000	25 / 10
24 x 16 x 8	Natural	2.000 / 3.000	20 / 10
22 x 20 x 4 *	Natural	2.000 / 3.000	20 / 10

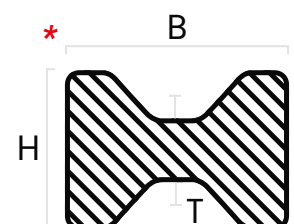
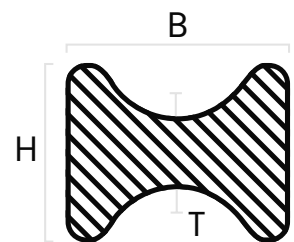

## CORNER SECTIONS

DESCRIPTION T x T [mm]	COLOUR	LENGHT [mm]	STANDARD PACK [pcs.]
6 x 6	Natural	2.000 / 2.500	50 / 50
8 x 8	Natural	2.000 / 2.500	25 / 25
10 x 10	Natural	2.000 / 2.500	20 / 20
7 x 7 *	Natural	2.000 / 2.500	50 / 50
12 x 12 *	Natural	2.000 / 2.500	10 / 10
16 x 16 *	Natural	2.000 / 3.000	10 / 5

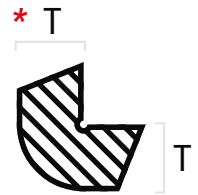
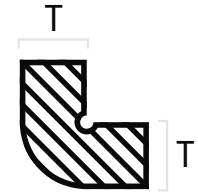

## HALF ROUND RODS

DESCRIPTION R x B [mm]	COLOUR	LENGHT [mm]	STANDARD PACK [pcs.]
3 x 1,5	Natural	2.000	100
4 x 2	Natural	2.000	100
5 x 2,5	Natural	2.000	100
6 x 3	Natural	2.000	100
7 x 3,5	Natural	2.000	100
8 x 4	Natural	2.000	100
12 x 6	Natural	2.000	50

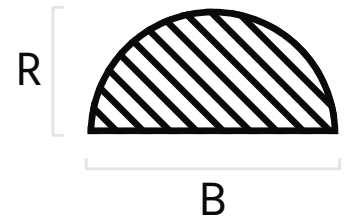

## ANGLES

DESCRIPTION B x H x T [mm]	COLOUR	LENGHT [mm]	STANDARD PACK [pcs.]
15 x 15 x 2	White	2.000	25
25 x 15 x 2	White	2.000	-
25 x 25 x 3	Red	6.000	-
30 x 30 x 3	Red	2.000 / 6.000	-
50 x 50 x 3	Red	6.000	-
60 x 60 x 3	Red	2.000 / 6.000	-
112 x 45 x 3	Red	6.000	-
30 x 30 x 5	Grey	6.000	-
35 x 35 x 5	Grey	6.000	-
50 x 50 x 5	Grey	6.000	-
60 x 60 x 5	Grey	6.000	-
75 x 50 x 8	Grey	6.000	-
100 x 100 x 8	Grey	6.000	-

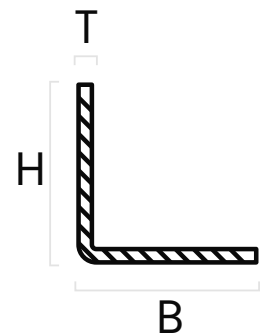

### C SECTION PROFILES

DESCRIPTION B X H X T1 X T2 [mm]	COLOUR	LENGHT [mm]	STANDARD PACK [pcs.]
60 x 60 x 5 x 5	Grey	6.000	-
200 x 60 x 10 x 10	Grey	6.000	-
300 x 100 x 15 x 15	Grey	6.000	-

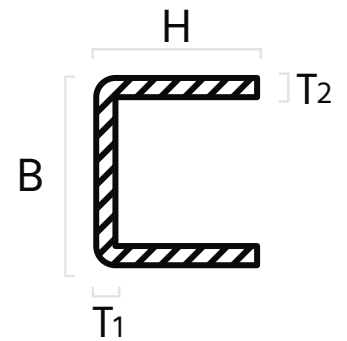

### H SECTION PROFILES

DESCRIPTION B X H X T1 X T2 [mm]	COLOUR	LENGHT [mm]	STANDARD PACK [pcs.]
100 x 50 x 8 x 8	Grey	6.000	-
120 x 60 x 8 x 8	Grey	6.000	-
150 x 75 x 8 x 8	Grey	6.000	-
200 x 100 x 10 x 10	Grey	6.000	-

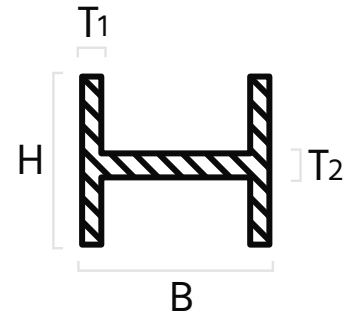

### SQUARE TUBES

DESCRIPTION B X H X T1 X T2 [mm]	COLOUR	LENGHT [mm]	STANDARD PACK [pcs.]
50 x 50 x 5 x 5	Grey	6.000	-
70 x 70 x 5 x 5	Grey	6.000	-
90 x 90 x 8 x 8	Grey	6.000	-

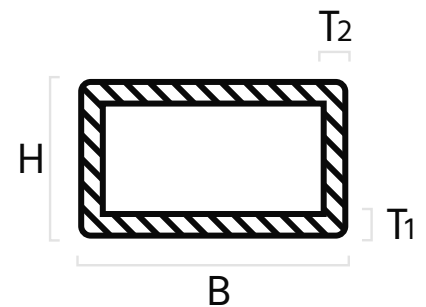

### TUBES

DESCRIPTION D EXT X D INT [mm]	COLOUR	LENGHT [mm]	STANDARD PACK [pcs.]
15 x 12	White	6.000	10
22 x 17	White	6.000	10
24,3 x 20,3	White	6.000	10
26 x 19	Grey	6.000	10
28,4 x 24,4	White	6.000	10
32,5 x 28,5	White	6.000	10
36,6 x 32,6	White	6.000	10
40 x 35	White	6.000	10

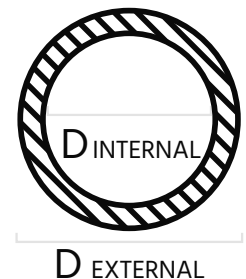

## FLAT SAIL BATTENS

DESCRIPTION B X H [mm]	COLOUR	LENGHT [mm]	STANDARD PACK [pcs.]
9 x 2,5	White	4.000	100
18 x 2	White	4.000	50
24 x 2,5	White	4.000	50
30 x 4,5	White	4.000	10
50 x 4	White	4.000	10

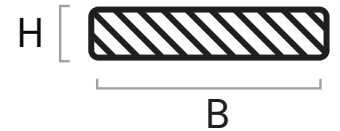

## RHOMBOID SAIL BATTENS

DESCRIPTION B X H [mm]	COLOUR	LENGHT [mm]	STANDARD PACK [pcs.]
15 x 3	White	4.000	50
24 x 4	White	4.000	25
30 x 3	White	4.000	25
40 x 4	White	4.000	20
50 x 4	White	4.000	10

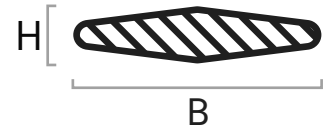

## HANDRAIL SYSTEM

DESCRIPTION [mm]	COLOUR	LENGHT [mm]	STANDARD PACK [pcs.]
Handrail 59 x 75	Grey	6.000	-
C section 60 x 60 x 5	Grey	6.000	-
Square tube 50 x 50 x 5	Grey	6.000	-
Tube 26 x 19	Grey	6.000	10
Skirting 150 x 15 x 3	Grey	6.000	-

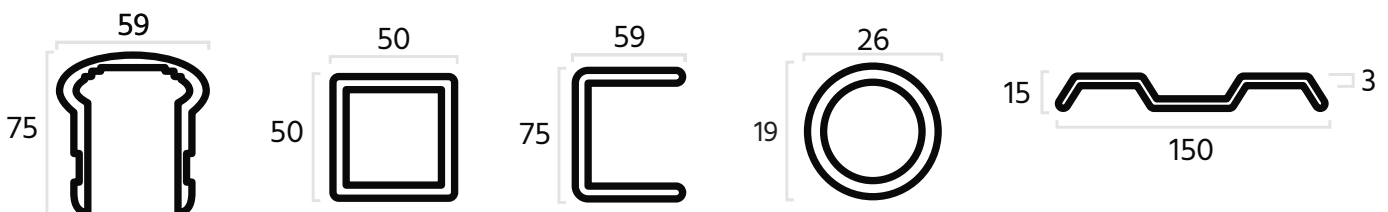
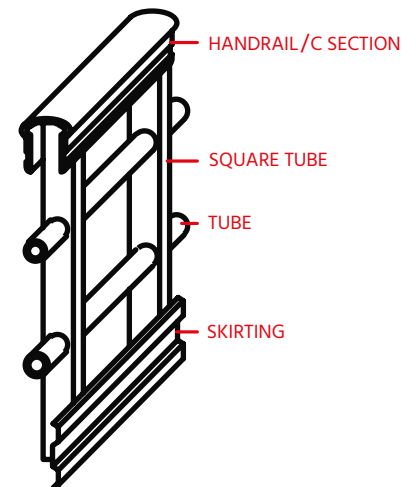

**TOP GLASS Industries S.p.A.**

Via dei Soldani, 3  
23875 Osnago (Lecco) - ITALY  
Ph. +39 039 95223.1 / Fax +39 039 587787  
Email: info@topglass.it

[www.topglass.com](http://www.topglass.com)



f in